

General Specifications

Electrical Capacity (Resistive Load)

Logic Level: 0.4VA maximum @ 28V AC/DC maximum
(Applicable Range 0.1mA ~ 0.1A @ 20mV ~ 28V)
Note: Find additional explanation of operating range in Supplement section.

Other Ratings

Contact Resistance: 80 milliohms maximum
Insulation Resistance: 500 megohms minimum @ 500V DC
Dielectric Strength: 500V AC minimum for 1 minute minimum
Mechanical Life: 50,000 operations minimum
Electrical Life: 50,000 operations minimum
Nominal Operating Force: 2.0N
Travel: Pretravel: .024" (0.6mm); Overtravel: .019" (0.5mm); Total Travel: .043" (1.1mm)

Materials & Finishes

Actuator: Polyphenylene sulfide (UL94V-0)
Case: Polyphenylene sulfide (UL94V-0)
Sealing Rings: Nitrile butadiene rubber
Movable Contacts: Phosphor bronze with gold plating
Stationary Contacts: Phosphor bronze with gold plating
Base: Polyphenylene sulfide (UL94V-0)
Terminals: Phosphor bronze with gold plating

Environmental Data

Operating Temperature Range: -30°C through +85°C (-22°F through +185°F)
Humidity: 90 ~ 95% humidity for 96 hours @ 40°C (104°F)
Vibration: 10 ~ 500Hz with peak-to-peak amplitude of 1.5mm traversing the frequency range & returning in 1 minute; 3 right angled directions for 2 hours
Shock: 50G (490m/s²) acceleration (tested in 6 right angled directions, with 5 shocks in each direction)

Installation

Mounting: It is recommended that the body of models for upright mounting without bracket be fastened to a panel or similar support for protection of solder joints from mechanical stress.
Coplanarity: See specifications in Terms & Acronyms in Supplement section.

Processing

Soldering: Reflow Soldering Recommended. See Profile B in Supplement section.
 Manual Soldering: See Profile B in Supplement section.
Cleaning: Automated cleaning. See Cleaning specifications in Supplement section.

Standards & Certifications

Flammability Standard: UL94V-0 actuator, case & base
 The G3B Series pushbuttons have not been tested for UL recognition or CSA certification. These switches are designed for use in a low-voltage, low-current, logic-level circuit. When used as intended in a logic-level circuit, the results do not produce hazardous energy.

Distinctive Characteristics

Ultra-miniature size allows high density mounting, and extremely light weight of 0.6 gram makes these switches ideal for handheld equipment.

Tape-reel and stick-tube packaging allow rapid automated placement of surface mount devices. Tape-reel packaging meets EIA-481-D Standard.

Heat resistant resin used for housing, base, and plunger allows vapor phase and infrared convection reflow soldering.

Combination of design features achieves total seal and allows automated processing techniques, including flux cleaning procedures: one-piece bushing and housing, rubber seals surrounding actuator and base, epoxy at joint of case and base, and molded-in, epoxy-sealed terminals.

Award-winning STC contact mechanism with benefits unavailable in conventional mechanisms: smoother, positive detent actuation, increased contact stability and unparalleled logic-level reliability. (Additional STC details in Terms & Acronyms; see Supplement section.)

Gull-wing terminals provide mechanical stability during soldering and simplified solder joint inspection.

Coplanarity: all considered surfaces must lie between two parallel planes that are a maximum distance apart of .0059" (0.15mm). (Additional coplanarity details in Terms and Acronyms in the Supplement section.)

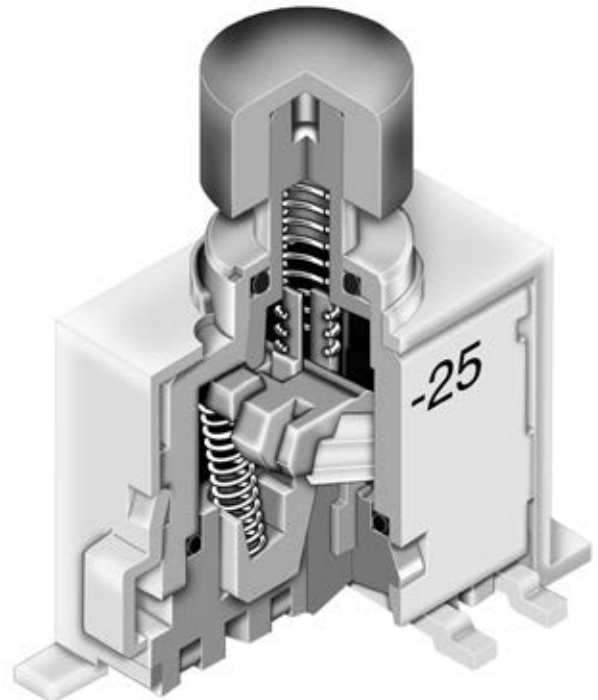

Actual Size



Toggles

Rockers

 Pushbuttons

Illuminated PB

Programmable

Keylocks

Rotaries

Slides

Tactiles

Tilt

Touch

Indicators

Accessories

Supplement

TYPICAL SWITCH ORDERING EXAMPLE

G3B **1** **5** **A** **B** — — —

Poles	
1	SPDT
2	DPDT

Plunger	
A	.130" (3.3mm) Long

Terminals	
P	Gull Wing for Upright Mount
B	Gull Wing for Upright with Bracket
H	Gull Wing for Right Angle

Colors	
A	Black
B	White
C	Red

Circuits		
5	ON	(ON)
() = Momentary		

Packaging	
No Code	Partitioned Tray for Upright & Right Angle - Any Quantity
R	Tape-Reel for Right Angle Only 500 Pieces/Reel
S	Stick-Tube for Upright Mount 50 Pieces/Stick

Optional Caps	
X	Slip-on Cap .157" (4.0mm) Diameter (For installation after processing only)
Y	Process Compatible Cap .157" (4.0mm) Diameter (Combines with R or S packaging only)

Packaging details at end of G3B Series

DESCRIPTION FOR TYPICAL ORDERING EXAMPLE

G3B15AB

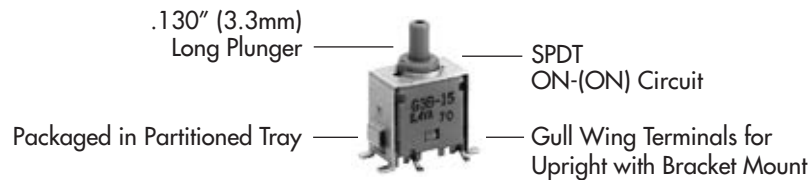

POLES & CIRCUITS

Pole	Model	Plunger Position () = Momentary		Connected Terminals		Throw & Schematics
		Normal	Down	Normal	Down	
SP	G3B15	ON 	(ON) 	5-6 	5-4 	SPDT
DP	G3B25	ON 	(ON) 	5-6 2-3 	5-4 2-1 	DPDT

Note: Terminal numbers are not actually on the switch.

Toggles
Rockers
Pushbuttons
Illuminated PB
Programmable
Keylocks
Rotaries
Slides
Tactiles
Tilt
Touch
Indicators
Accessories
Supplement

PLUNGER & OPTIONAL CAPS

A .130" (3.3mm)
Long Plunger

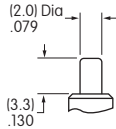

X AT4063 Slip-on Cap
.157" (4.0mm) Diameter

Available with bulk packaging only. Cap must be installed after processing.

Material: Polyamide
Finish: Glossy



Actual Size

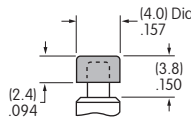

Y Process Compatible Cap
.157" (4.0mm) Diameter

Factory assembled. Available with tape-reel or stick-tube packaging only.

Caution: Pulling force specification for this cap is not warranted after reflow processing.

Material: Polyamide
Finish: Glossy

Cap Colors Available:



Black



White



Red

TYPICAL SWITCH DIMENSIONS

Single & Double Pole

Upright Mounting

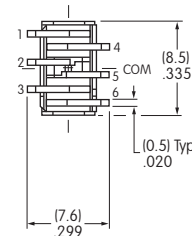
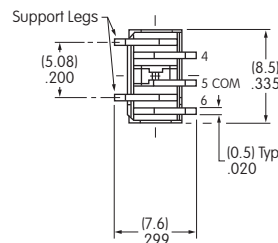
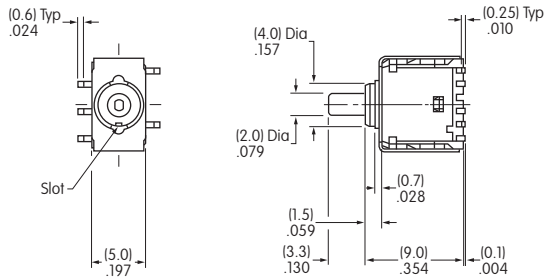

G3B25AP

Single & Double Pole

Upright Mounting with Bracket

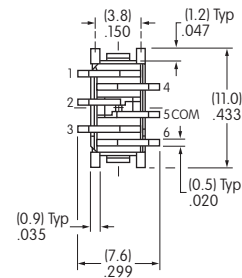
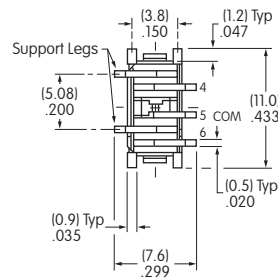
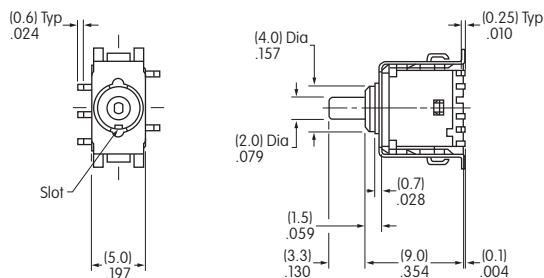

G3B15AB

Right Angle Mounting

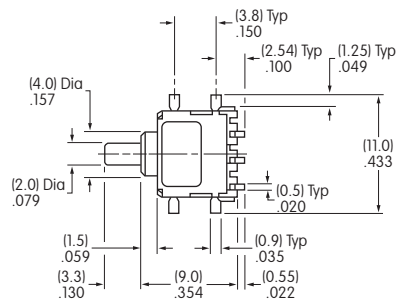

Single Pole

Double Pole

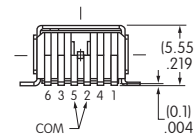
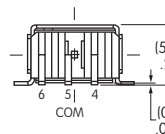
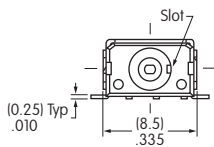

G3B15AH

Toggles

Rockers

Pushbuttons

Illuminated PB

Programmable

Keylocks

Rotaries

Slides

Tactiles

Tilt

Touch

Indicators

Accessories

Supplement

Pad Layouts for Surface Mount Terminals

Single Pole Double Throw

Upright Mounting

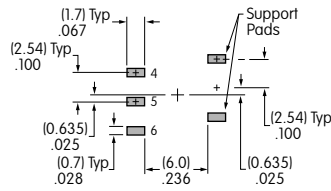

Upright Mounting with Bracket

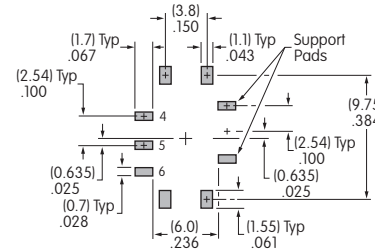

Right Angle Mounting

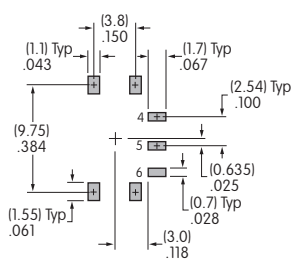

Double Pole Double Throw

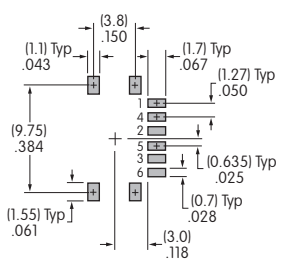
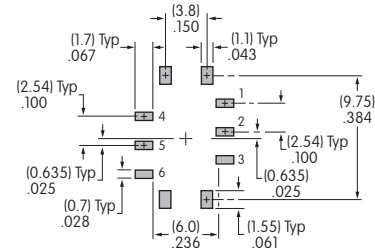
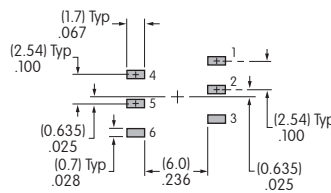

PACKAGING

No Code

Partitioned Tray for Upright & Right Angle

Any quantity

If the G3 upright models are ordered in less than 50-piece increments or the right angle models in less than 500-piece increments, the switches are packaged in a partitioned tray. No code is required.



R

Tape-Reel for Right Angle

500 pieces per reel

Switches must be ordered in 500-piece increments when tape-reel packaging is selected.

This packaging meets EIA-481-D Standard for "16mm and 24mm Embossed Carrier Taping of Surface Mount Components for Automatic Handling."



PACKAGING (CONTINUED)

S Stick-Tube for Upright Mount

50 pieces per stick

Switches must be ordered in 50-piece increments when stick-tube packaging is selected.

Note: Possible deformation of the Stick-Tube and Tape-Reel may occur when environmental temperature exceeds 50°C (122°F). It is recommended to store the product on a flat surface within normal temperature and humidity ranges.
 Temperature range: 5° ~ 35°C (41° ~ 95°F).
 Relative humidity range: 45 ~ 85%.
 The maximum stacking limit is 10 when storing the products.



Tape-Reel Packaging for Right Angle Mount

Each tape-reel of 550 pockets contains 500 switches.

Minimum Leader Length: 7.87" (200mm) Minimum Trailer Length: 1.97" (50mm)

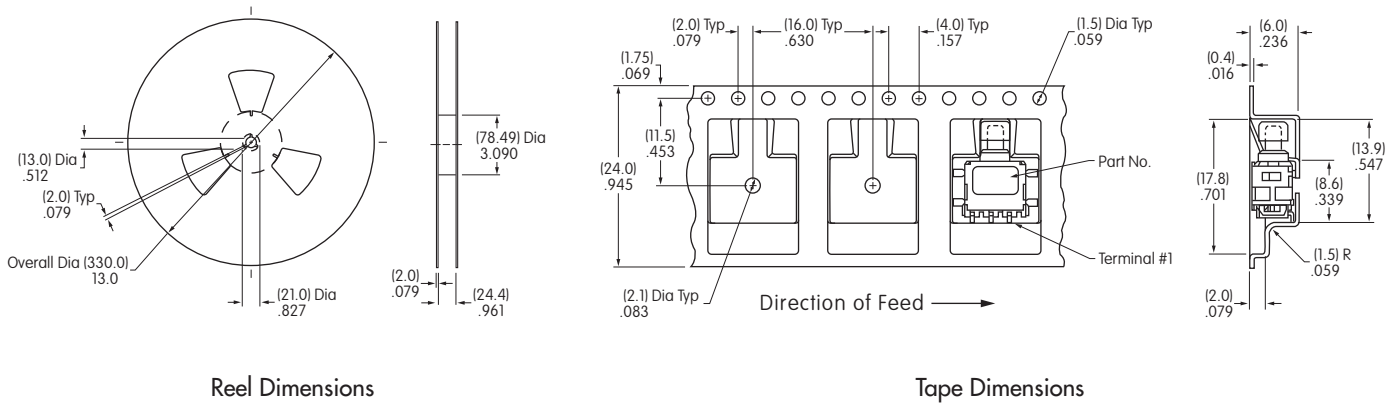

Stick-Tube Packaging for Upright Mount

Each stick-tube contains 50 switches.

L = Length

G3B Upright (code P)
18.31" (465mm)

G3B Upright with Bracket (code B)
21.26" (540mm)

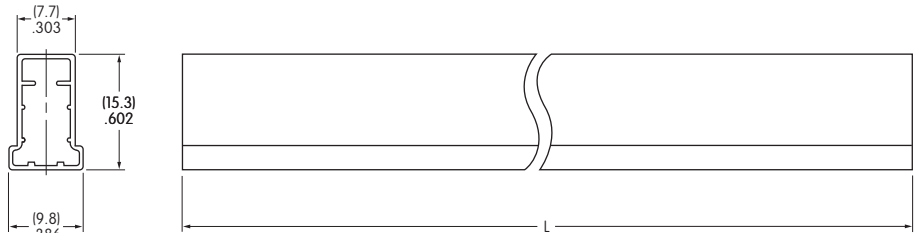

Stick-Tube Dimensions

Toggles
 Rockers
 Pushbuttons
 Illuminated PB
 Programmable
 Keylocks
 Rotaries
 Slides
 Tactiles
 Tilt
 Touch
 Indicators
 Accessories
 Supplement