

A General Specifications

Electrical Capacity (Resistive Load)

Logic Level: 0.4VA maximum @ 28V AC/DC maximum
(Applicable Range 0.1 mA ~ 0.1 A @ 20mV ~ 28V)
Note: Find additional explanation of operating range in Supplement section.

Other Ratings

Contact Resistance: 50 milliohms maximum
Insulation Resistance: 500 megohms minimum @ 500V DC
Dielectric Strength: 500V AC minimum for 1 minute minimum
Mechanical Life: 100,000 operations minimum for On-None-On & On-Off-On
50,000 operations minimum for other circuits
50,000 operations minimum for locking lever models

Electrical Life: 50,000 operations minimum
Nominal Operating Force: Toggles A, A1, E & K with Long Paddle: 1.47N (momentary); 1.18N (maintained)
Toggles J & H & K with Short Paddle: 2.72N (momentary); 1.84N (maintained)
Toggle L: 0.59N

Contact Timing: Nonshorting (break-before-make)
Angle of Throw: 26°

Materials & Finishes

Toggle: Nickel plated brass
Bushing: Carbon blended polyamide; nickel plated zinc alloy for locking levers & threaded bushing
Gasket: Nitrile butadiene rubber
Case Housing: Glass fiber reinforced polyamide
Support Bracket: Tin plated phosphor bronze
Movable Contact: Phosphor bronze with gold plating
Stationary Contacts: Copper alloy with gold plating
Terminals: Copper alloy with gold plating

Environmental Data

Operating Temperature Range: -30°C through +85°C (-22°F through +185°F)
Humidity: 90 ~ 95% humidity for 96 hours @ 40°C (104°F)
Vibration: 10 ~ 55Hz with peak-to-peak amplitude of 1.5mm traversing the frequency range & returning in 1 minute; 3 right angled directions for 2 hours
Shock: 50G (490m/s²) acceleration (tested in 6 right angled directions, with 5 shocks in each direction)

Installation

Mounting Torque: .30 ~ .45Nm (2.65 ~ 3.98 lb•in) for A1 actuator with threaded bushing only

PCB Processing

Soldering: Wave Soldering Recommended: See Profile A in Supplement section.
Manual Soldering: See Profile A in Supplement section.
Cleaning: Automated cleaning. See Cleaning specifications in Supplement section.

Standards & Certifications

Flammability Standards: UL94V-0 available
The B Series toggles have not been tested for UL recognition or CSA certification.
These switches are designed for use in a low-voltage, low-current, logic-level circuit.
When used as intended in a logic-level circuit, the results do not produce hazardous energy.

Distinctive Characteristics

Subminiature size saves space on PC boards.

Specifically developed for logic-level applications.

Antistatic superstructure, consisting of the carbon impregnated bushing and the support bracket, prevents static discharge to the contacts. Static electricity from an operator's touch travels from actuator through the bushing and bracket to the PC board.

Locking lever mechanism offered as a toggle option.

Optional threaded, 6mm diameter bushing for panel seal mounting meets IP65 of IEC60529 specifications (similar to NEMA 4 and 13).

Totally sealed body construction prevents contact contamination and allows time- and money-saving soldering and cleaning. Epoxy sealed terminals lock out flux and other contaminants.

Award-winning STC contact mechanism with benefits unavailable in conventional mechanisms: smoother, positive detent actuation, increased contact stability and unparalleled logic-level reliability. (Additional STC details in Terms & Acronyms; see Supplement section.)

.100" x .100" (2.54mm x 2.54mm) terminal spacing conforms to standard PC board grid spacing.

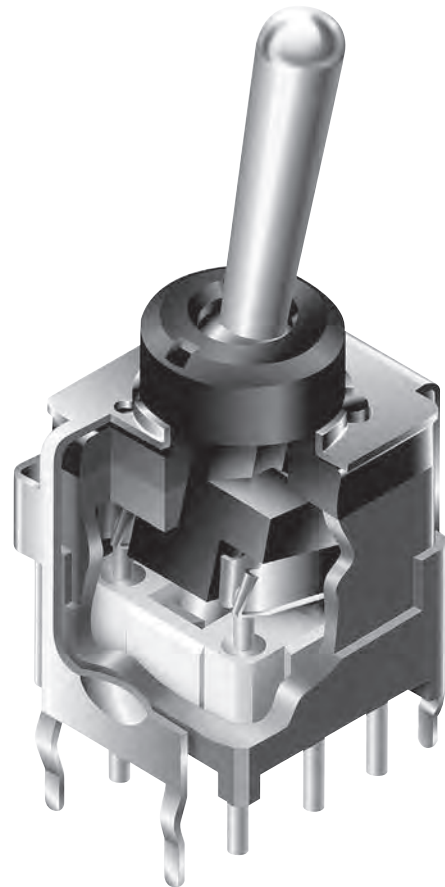

Actual Size

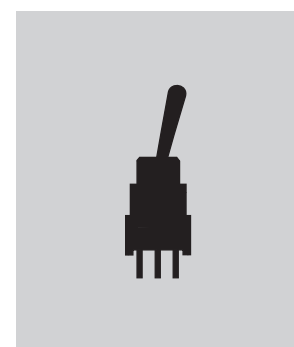

- A Toggles
- Rockers
- Pushbuttons
- Illuminated PB
- Programmable
- Key locks
- Rotaries
- Slides
- Tactiles
- Tilt
- Touch
- Indicators
- Accessories
- Supplement

TYPICAL SWITCH ORDERING EXAMPLE

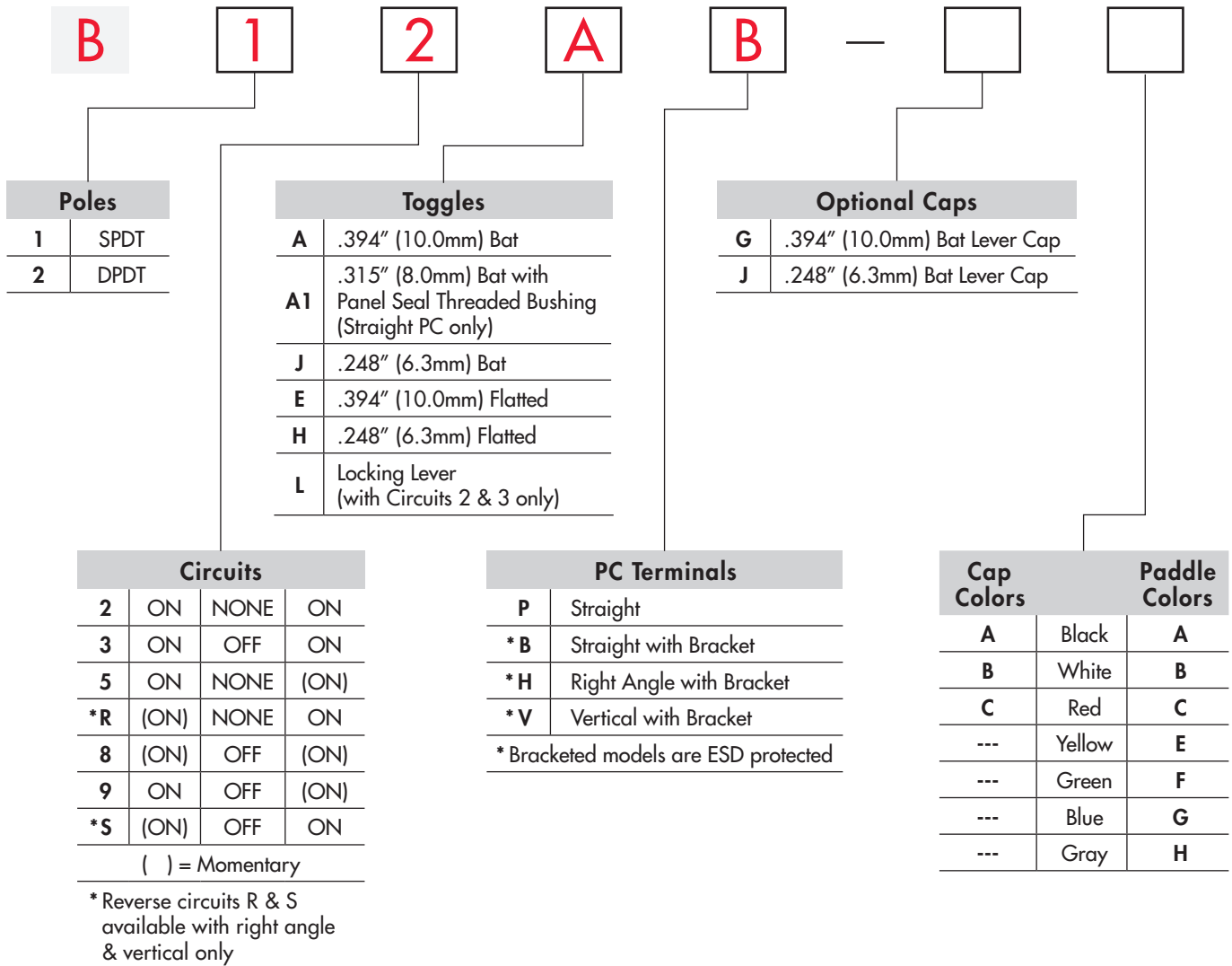

DESCRIPTION FOR TYPICAL ORDERING EXAMPLE

B12AB

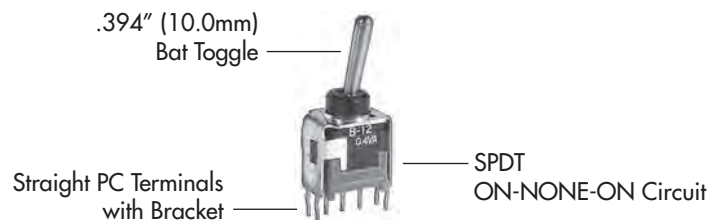

POLES & CIRCUITS

Pole	Model	Toggle Position () = Momentary			Connected Terminals			Throw & Schematics
		Up	Center	Down	Up	Center	Down	
								Note: Terminal numbers are not actually on the switch.
SP	B12 B13 B15 B1R B18 B19 B1S	ON ON ON (ON) (ON) ON (ON)	NONE OFF NONE NONE OFF OFF OFF	ON ON (ON) ON (ON) (ON) ON	2-3	OPEN	2-1	SPDT
DP	B22 B23 B25 B2R B28 B29 B2S	ON ON ON (ON) (ON) ON (ON)	NONE OFF NONE NONE OFF OFF OFF	ON ON (ON) ON (ON) (ON) ON	2-3 5-6	OPEN	2-1 5-4	DPDT

TOGGLES

Standard Material & Finish: Brass with Bright Nickel

A .394" (10.0mm)
Bat

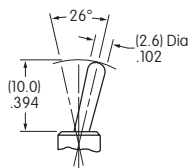

A1 .315" (8.0mm) Bat with
Panel Seal Threaded Bushing

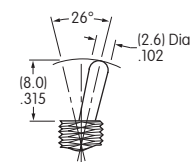

J .248" (6.3mm)
Bat

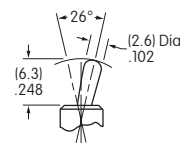

E .394" (10.0mm)
Flatted

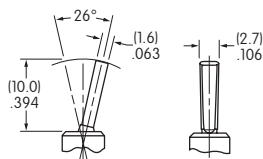

H .248" (6.3mm) Flatted

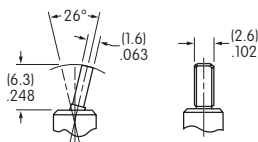

L Locking Lever

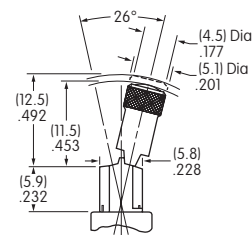

PC TERMINALS

Use of a support bracket is recommended to increase PCB mounting strength and stability.

P Straight

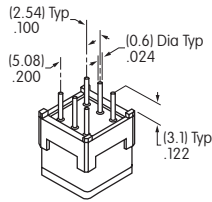

B Straight with Bracket

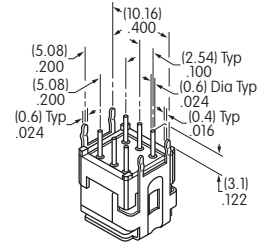

H Right Angle with Bracket

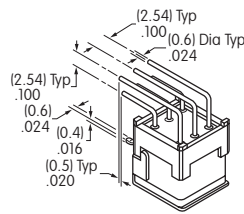

V Vertical with Bracket

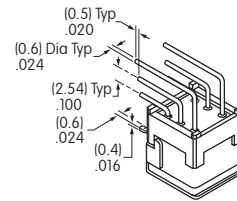

OPTIONAL CAPS

G AT4003
.394" (10.0mm) Bat Lever Cap

Material: PVC
Colors Available:
A, B, C

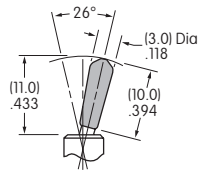

J AT4064
.248" (6.3mm) Bat Lever Cap

Material: PVC
Colors Available:
A, B, C

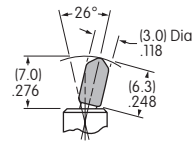

Color Codes:

- A** Black
- B** White
- C** Red
- E** Yellow
- F** Green
- G** Blue
- H** Gray

TYPICAL SWITCH DIMENSIONS

Single Pole

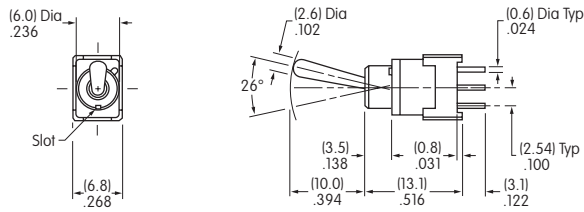

Straight PC

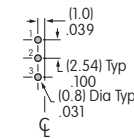

B12AP

Double Pole

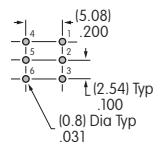
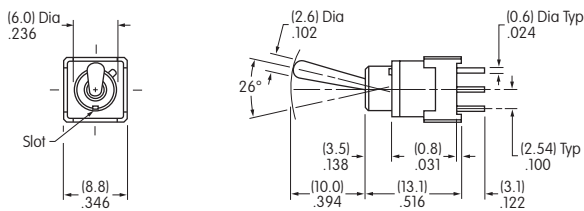

B22AP

Single Pole

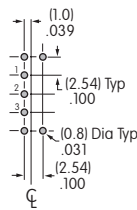
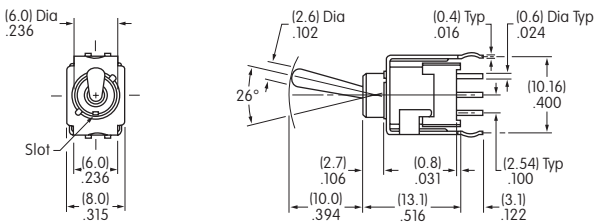

B12AB

Double Pole

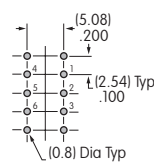
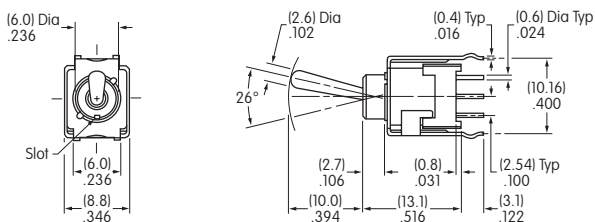

B22AB

Single Pole

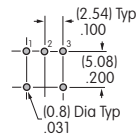
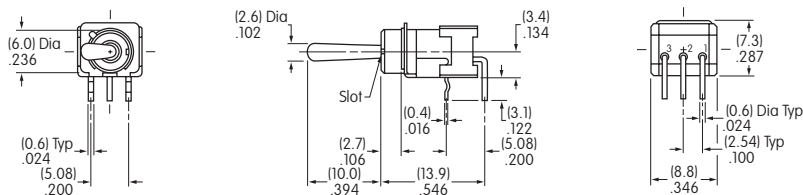

B12AH

A
Toggles

Rockers

Pushbuttons

Illuminated PB

Programmable

Key locks

Rotaries

Slides

Tactiles

Tilt

Touch

Indicators

Accessories

Supplement

TYPICAL SWITCH DIMENSIONS

Right Angle PC



B22AH

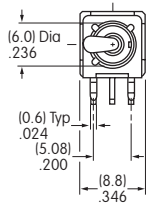

Double Pole

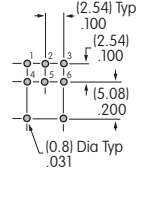
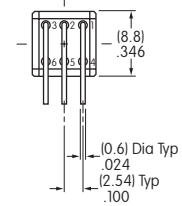
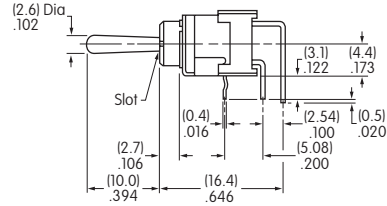

Vertical PC



B12AV

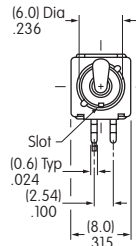

Single Pole

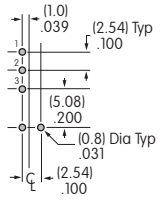
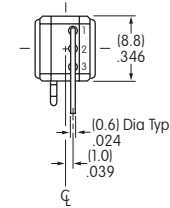
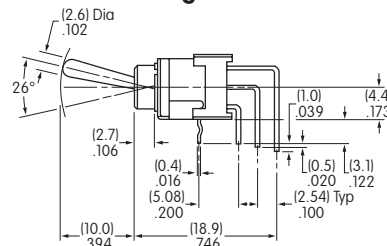

Vertical PC



B22AV

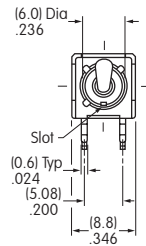

Double Pole

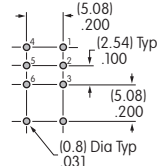
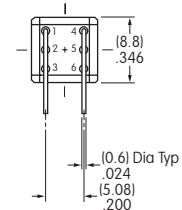
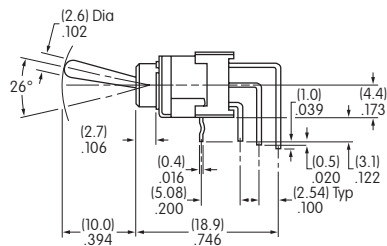

Locking Lever • Straight PC • Bracket



B12LB

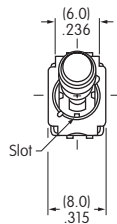

Single Pole

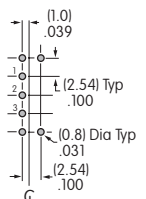
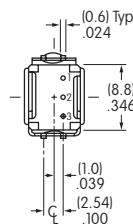
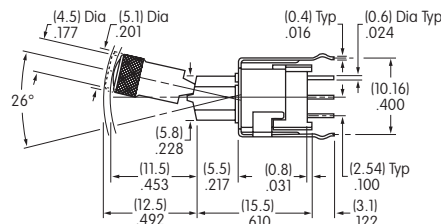

Locking Lever • Straight PC • Bracket



B22LB

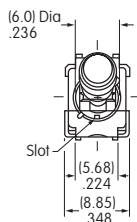

Double Pole

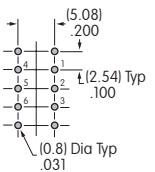
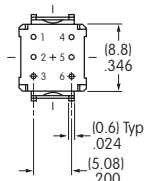
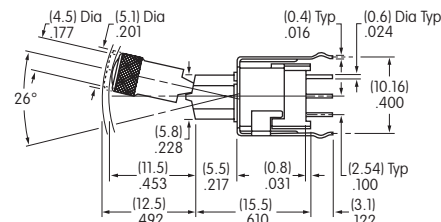

Toggles
 Rockers
 Pushbuttons
 Illuminated PB
 Programmable
 Keylocks
 Rotaries
 Slides
 Tactiles
 Locking Lever • Straight PC • Bracket
 Tilt
 Touch
 Indicators
 Accessories
 Supplement

TYPICAL SWITCH DIMENSIONS

Panel Seal • Single Pole

Threaded Bushing • Straight PC

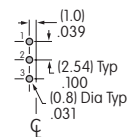
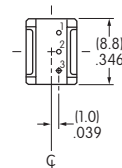
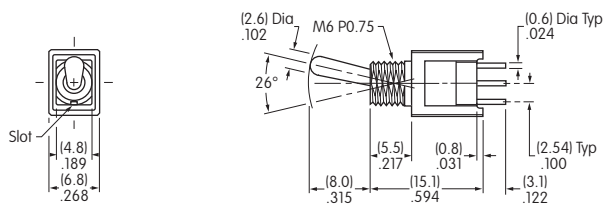

B12A1P

Panel Seal • Double Pole

Threaded Bushing • Straight PC

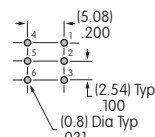
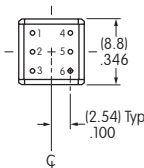
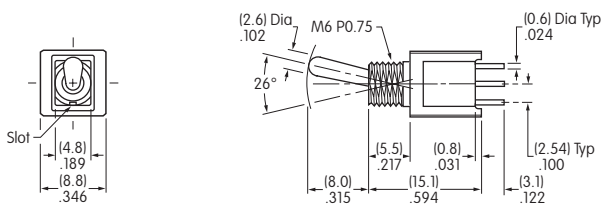

B22A1P

STANDARD HARDWARE & PANEL CUTOUT

AT513M
Metric Hex Nut

Material:
Brass,
Nickel plated

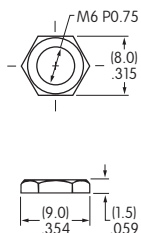

AT063
Gasket

Material:
Nitrile butadiene
rubber

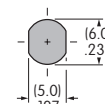
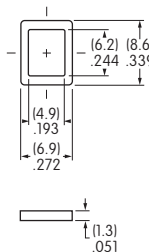

Maximum Panel Thickness
with Standard Hardware:
.087" (2.2mm)

General Specifications

Electrical Capacity (Resistive Load)

Logic Level: 0.4VA maximum @ 28V AC/DC maximum
(Applicable Range 0.1mA ~ 0.1A @ 20mV ~ 28V)
Note: Find additional explanation of operating range in Supplement section.

Other Ratings

Contact Resistance: 50 milliohms maximum
Insulation Resistance: 500 megohms minimum @ 500V DC
Dielectric Strength: 500V AC minimum for 1 minute minimum
Mechanical Life: 100,000 operations minimum
Electrical Life: 50,000 operations minimum
Nominal Operating Force: 1.18N
Contact Timing: Nonshorting (break-before-make)
Angle of Throw: 26°

Materials & Finishes

Actuator: Polyamide
Bushing Housing: Polyamide
Case Housing: Glass fiber reinforced polyamide
Support Bracket: Phosphor bronze with tin plating
Movable Contact: Phosphor bronze with gold plating
Stationary Contacts: Brass with tin plating
Terminals: Brass with gold plating

Environmental Data

Operating Temperature Range: -25°C through +55°C (-13°F through +131°F)
Humidity: 90 ~ 95% humidity for 240 hours @ 40°C (104°F)
Vibration: 10 ~ 55Hz with peak-to-peak amplitude of 1.5mm traversing the frequency range & returning in 5 minutes; 3 right angled directions for 2 hours
Shock: 50G (490m/s²) acceleration (tested in 3 right angled directions, with 5 shocks in each direction)

PCB Processing

Soldering: Wave Soldering recommended. See Profile A in Supplement section.
Manual Soldering: See Profile A in Supplement section.
Cleaning: Automated alcohol based cleaning recommended, 5 minutes maximum. Do not use high-purity alcohol (50% alcohol or more) or organic solvent. High alcohol solution can damage clear plastic. See Cleaning specifications in Supplement section.

Standards & Certifications

The B Series illuminated toggles have not been tested for UL recognition or CSA certification. These switches are designed for use in a low-voltage, low-current, logic-level circuit. When used as intended in a logic-level circuit, the results do not produce hazardous energy.

Distinctive Characteristics

LED provides maximum illumination to bushing and actuator, indicating actuator status in highly visible green, red, or amber for single color or red/green for bicolor.

Totally sealed body construction prevents contact contamination and allows time- and money-saving automated soldering and cleaning. Molded-in, epoxy sealed terminals lock out flux and other contaminants.

Award-winning STC contact mechanism with benefits unavailable in conventional mechanisms: smoother, positive detent actuation, increased contact stability, and unparalleled logic-level reliability. (Additional STC details in Terms & Acronyms; see Supplement section.)

.100" x .100" (2.54mm x 2.54mm) terminal spacing conforms to standard PC board grid spacing.

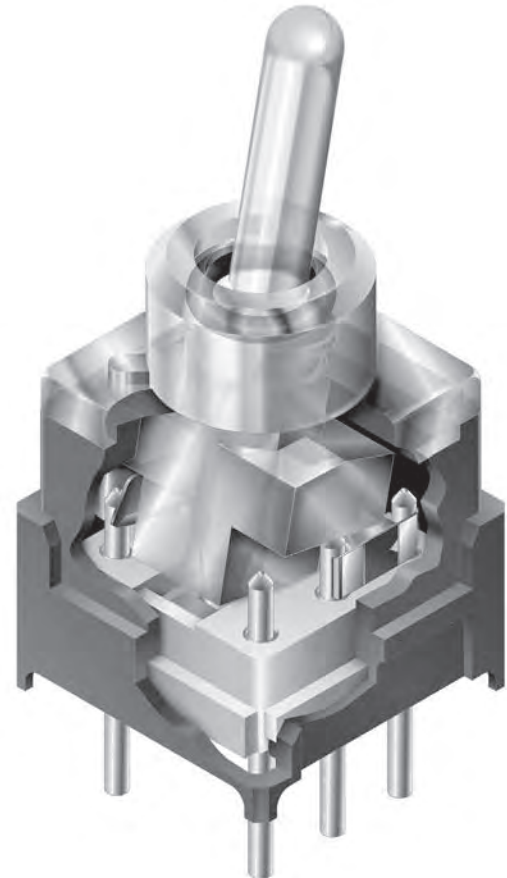

Actual Size

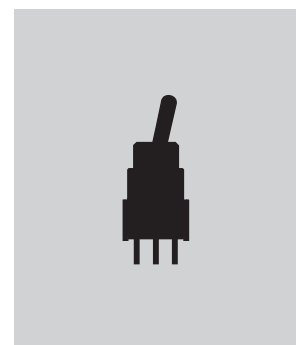

A
Toggles

Rockers

Pushbuttons

Illuminated PB

Programmable

Keylocks

Rotaries

Slides

Tactiles

Tilt

Touch

Indicators

Accessories

Supplement

Toggles
A

TYPICAL SWITCH ORDERING EXAMPLE

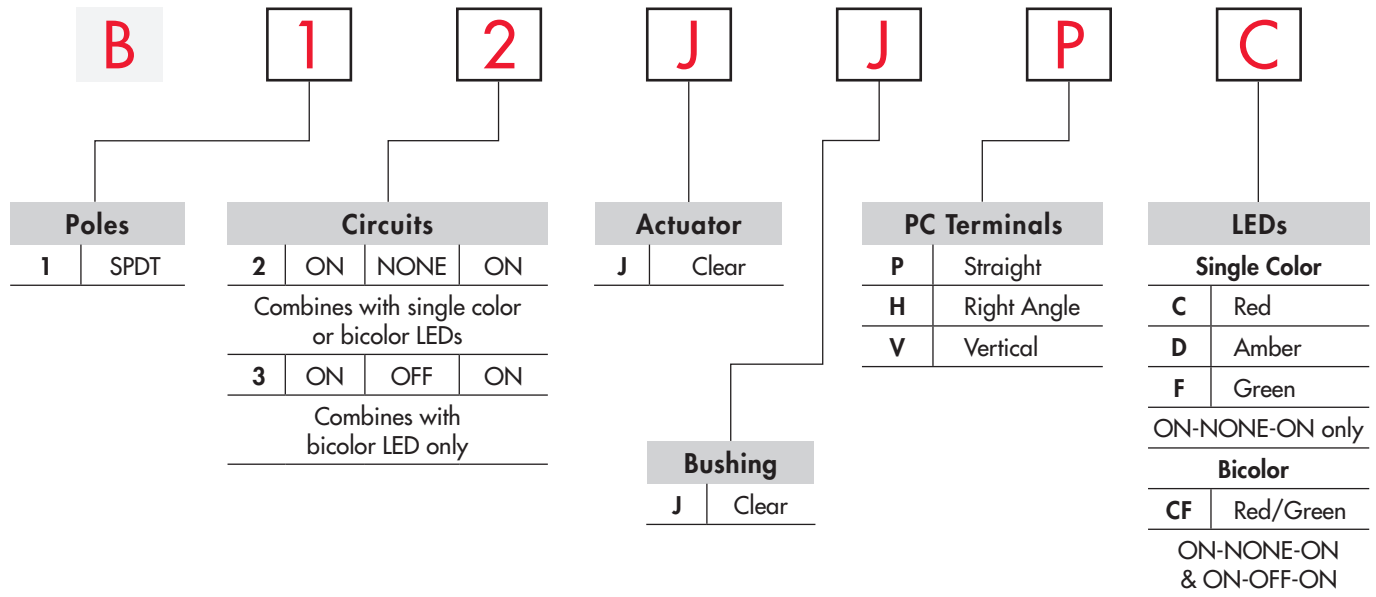

DESCRIPTION FOR TYPICAL ORDERING EXAMPLE

B12JJPC

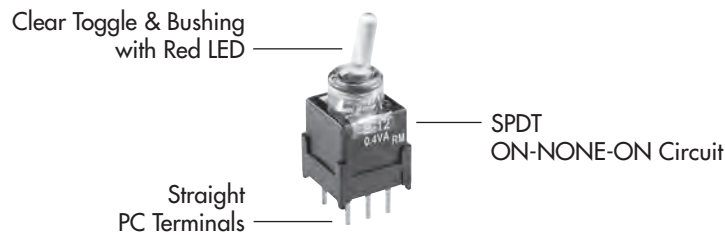

POLE & CIRCUITS

Pole Throw	Model	Toggle Position			Connected Terminals			Throw & Schematics
		Up	Center	Down	Up	Center	Down	
SPDT	B12	ON	NONE	ON	2-3	NONE	2-1	Note: Terminal numbers are not actually on the switch. LED circuit is isolated and requires an external power source. Single Color
	B13	ON	OFF	ON	2-3	OPEN	2-1	

ACTUATOR & BUSHING

J Clear Toggle

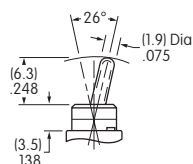

J Clear Bushing

Rockers

Pushbuttons

Illuminated PB

Programmable

Keylocks

Rotaries

Slides

Tactiles

Tilt

Touch

Indicators

Accessories

Supplement

LED COLORS & SPECIFICATIONS

LEDs are an integral part of the switch and not available separately. The electrical specifications shown are determined at a basic temperature of 25°C. If the source voltage exceeds the rated voltage, a ballast resistor is required. The resistor value can be calculated by using the formula in the Supplement section.

	Colors	Single Color			Bicolor
		C Red	D Amber	F Green	CF Red/Green
Maximum Forward Current	I_{FM}	30mA	30mA	25mA	30mA/25mA
Typical Forward Current	I_F	20mA	20mA	20mA	20mA/20mA
Forward Voltage	V_F	1.95V	2.0V	3.3V	1.95V/3.3V
Maximum Reverse Voltage	V_{RM}	5V	5V	5V	5V/5V
Current Reduction Rate Above 25°C	ΔI_F	0.40mA/°C		0.33mA/°C	0.40mA/°C/0.33mA/°C
Ambient Temperature Range		-25°C ~ +55°C			

PC TERMINALS

P Straight

H Right Angle with Bracket

V Vertical with Bracket

TYPICAL SWITCH DIMENSIONS

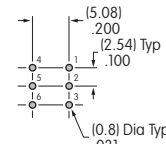
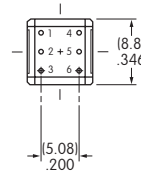
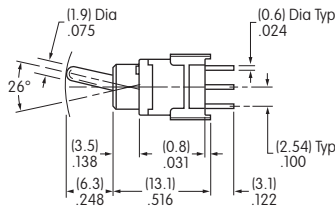
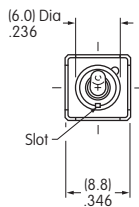

Straight PC



B12JPC

Terminal 4 is a support pin on single color models.

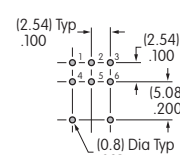
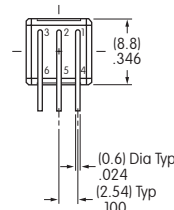
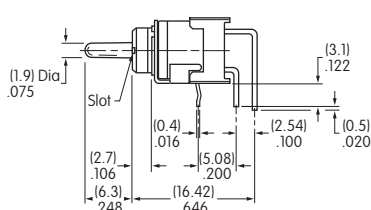
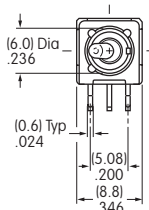
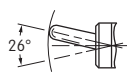

Right Angle PC



B13JHCF

Terminal 4 is a support pin on single color models.

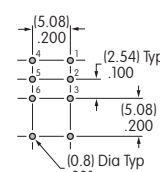
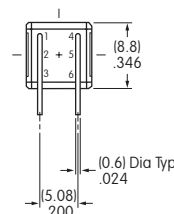
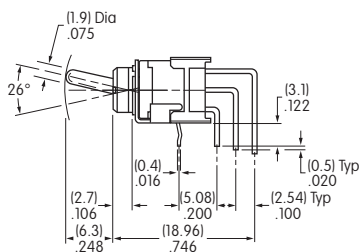
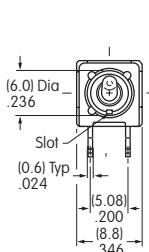

Vertical PC



B13JVC

Terminal 4 is a support pin on single color models.